

Features

- Reverse polarity protection and overload protection(DC)
- Operation confirmed easily by a red indicator lamp
- Wide range of applications(for replacement of micro switch, limit switch, etc.)
- Ip67 (IEC standard)
- Enhanced noise - Resistance by using exclusive IC (DC Power)

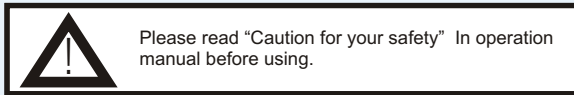

Ordering information (cylindrical DC power switch)

IPS	B	BR	N	12	P	O	20	W	02
Inductive proximity switch	B-Brass P-Plastic	BR-Barrel	F-Flush N-Nonflush	Indicate size(mm) barrel dia.	P-PNP N-NPN	O-NO C-NC	20-200mA 30-300mA 50-500mA (Load current)	W-Wire C-Conn.	Cable length (mtr.)

Specifications

Model Type	IPS-12	
Dimensions (mm)	M12 × 1*	
Housing material	Brass, nickel-plated	
Indicator	Red LED	
Power supply	10 ... 30 V DC	
Control output	200mA	
Leakage current	Max. 0.9mA	
Switching output	PNP or NPN	
Output function	NO or NC	
Installation	Flush	Non-flush
Sensing distance (mm)	2	4
Response frequency Hz	800	400
Hysteresis	10 ... 15% of Sn	
Ambient humidity	35 ... 95% RH	
Ambient temperature	0 deg. C. to 70 deg. C.	

* Barrel thread pitch 1mm

Please contact factory for customize product

Specifications are subject to change without prior intimation

NONFLUSH

FLUSH

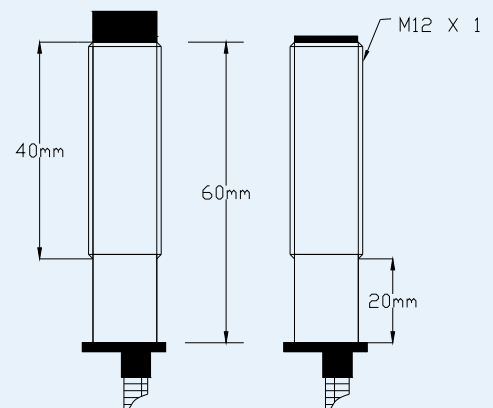

Standard Model:

IPS-BBRN12-PO20W02
IPS-BBRN12-NO20W02
IPS-BBRF12-PO20W02
IPS-BBRF12-NO20W02

IPS-BBRN12-PC20W02
IPS-BBRN12-NC20W02
IPS-BBRF12-PC20W02
IPS-BBRF12-NC20W02

Connection detail

